

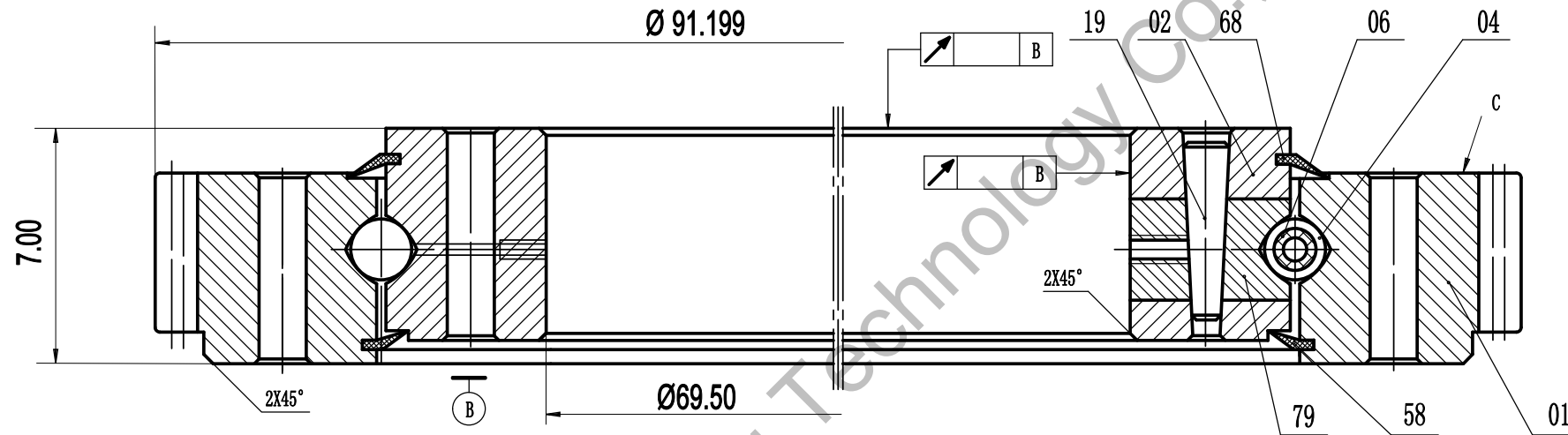

DP		1.75
Number of teeth	Z	158
Addendum modification	x	0
Pressure angle	a	20°
Accuracy grade		10-ISO 1328/97



Remark:

1. Luoyang JCB Bearing Technology Co., Ltd is a technical Inc, specialize in designing and manufacturing slewing ring bearing, we can design and manufactur all kinds of slewing bearing according to client's requirement.
2. This drawing is reference for user, if you need formal drawing, please contact wth us sales@jcb-bearing.com, the official drawing will be submitted after order confirmation.

Contact information

Company Address : No.3 Lianmeng road, Luoyang, Henan, China.
 Postal code : 471003
 Phone : 86-379-68611678 Fax : 86-379-68611679
 E-mail: sales@jcb-bearing.com
 Reserved E-mail: sales@slewing-ring-bearings.com
 Website: www.jcb-bearing.com
 www.slewing-ring-bearings.com



Series 3000	A18-80E1	
	<small>weight (lbs)</small>	
	4806	
	Luoyang JCB Bearing Technology Co., Ltd	